

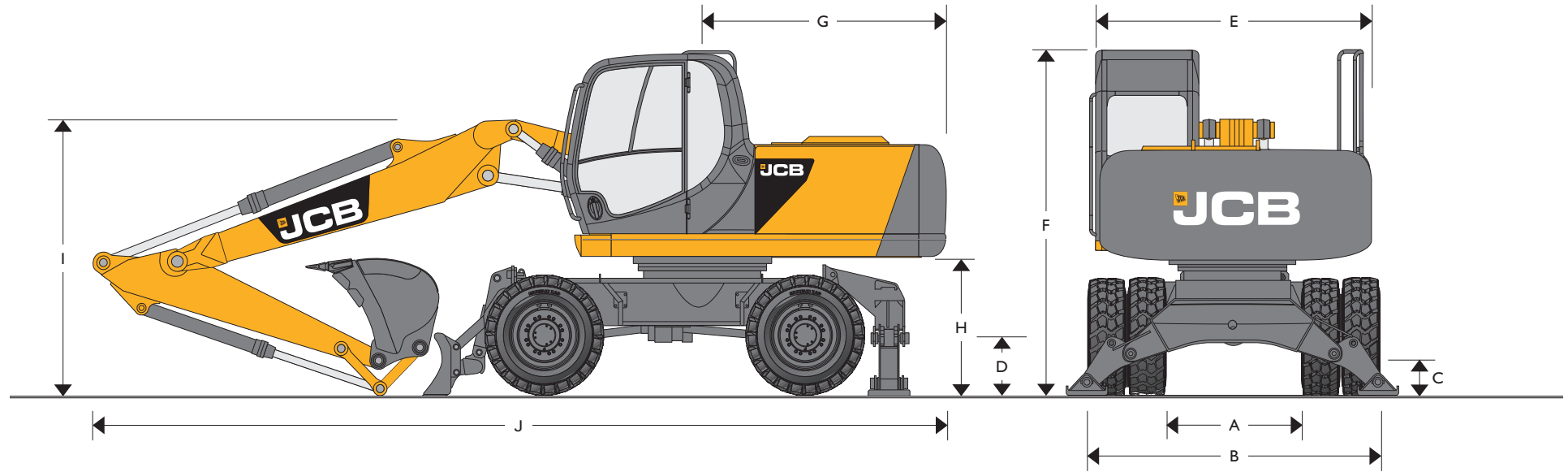

MAX. OPERATING WEIGHT: 17820 kg (39286 lb) ENGINE POWER: 97 kW (130 hp)



STATIC DIMENSIONS

Dimensions in millimetres (ft-in)		
A	Internal width between dual wheels	1330 (4-4)
B	External width between dual wheels	2490 (8-2)
C	Ground clearance	350 (1-1)
D	Height to axle centre line dual wheels	498 (1-7)
	Height to axle centre line single wheels	519 (1-8)
E	Overall width (handrail removed)	2480 (8-2)
F	Height over cab	3195 (10-5)
G	Tail length	2330 (7-4)
H	Clearance under counterweight	1270 (4-2)

Monoboom

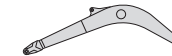

Dipper length		2.25m (7ft 5in)	2.70m (8ft 10in)	3.05m (10ft 0in)	
I	Transport boom height	mm (ft-in)	2765 (9-1)	2765 (9-1)	3240 (10-7)
J	Transport length	mm (ft-in)	8285 (26-8)	8275 (26-7)	8446 (27-3)

Triple articulated boom



Dipper length		2.25m (7ft 5in)	2.70m (8ft 10in)	3.05m (10ft 0in)	
I	Transport boom height	mm (ft-in)	2806 (9-2)	2874 (9-5)	3136 (10-3)
J	Transport length	mm (ft-in)	8263 (26-7)	8258 (26-7)	8223 (26-6)

CHASSIS OPTIONS

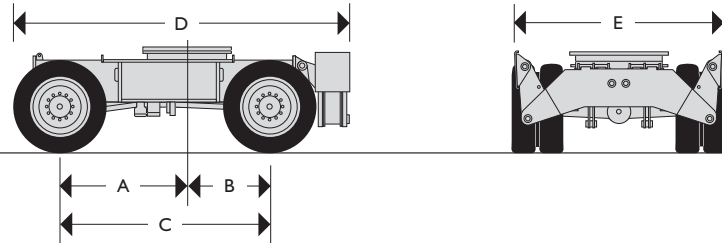

Dimensions in millimetres (ft-in)

A	Centre of slew ring to front axle	1500 (4-11)
B	Centre of slew ring to rear axle	1000 (3-3)
C	Wheelbase	2500 (8-2)
D	Length including rear stabilizers	3950 (12-11)
E	Width over stabilizers (raised)	2480 (8-1)

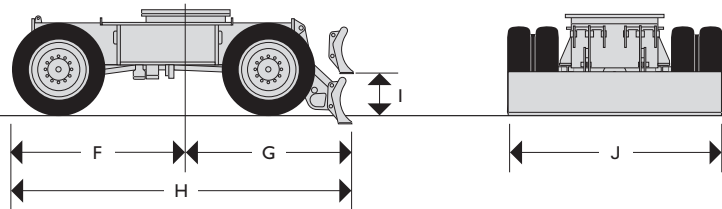

Dimensions in millimetres (ft-in)

F	Centre of slew ring to face of front tyre	1990 (6-6)
G	Centre of slew ring to rear dozer blade (lowered)	2090 (6-10)
H	Length including rear dozer blade (raised)	4050 (13-3)
I	Ground level to bottom of rear dozer blade (raised)	450 (1-6)
J	Dozer blade width	2480 (8-1)

CHASSIS OPTIONS

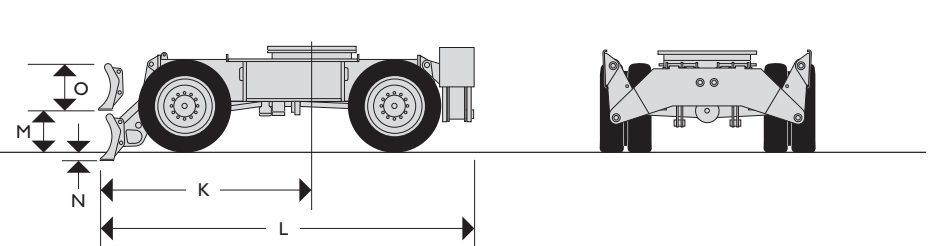

Dimensions in millimetres (ft-in)

K	Centre of slew ring to front dozer blade (lowered)	2530 (8-3)
L	Length including stabilizers and dozer blade (raised)	4460 (14-7)
M	Ground level to bottom of front dozer blade (raised)	450 (1-6)
N	Dozer blade dig depth	130 (0-5)
O	Dozer blade height	500 (1-8)

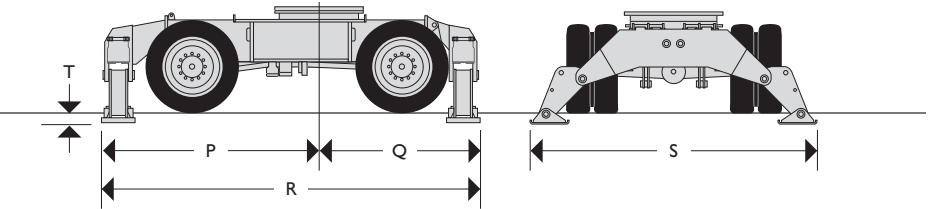

Dimensions in millimetres (ft-in)

P	Centre of slew ring to front stabilizers	2520 (8-3)
Q	Centre of slew ring to rear stabilizers	1960 (6-5)
R	Length including front and rear stabilizers	4480 (14-8)
S	Width over stabilizers (lowered)	3550 (11-8)
T	Stabilizer lift height	130 (0-5)



ENGINE

Model	JCB Dieslemax 444 TCA-97 Eu Stage IIIA, EPA Tier 3 compliant.
Type	Water cooled, 4-stroke, 4-cylinder in-line, direct injection, turbocharged diesel.
Rated power (ISO14899 (SAE J1995))	97kW (130hp) at 2200rpm.
Piston Displacement	4.399 litres (1.16 UK gal).
Injection	Electronic injection.
Air Filtration	Dry element with secondary safety element and in cab warning indicator.
Cooling	Large capacity radiator.
Starting system	24 volt – 4kW.
Batteries	2 x 12 volt Heavy Duty.
Alternator	24 volt 55 amp.
Refuelling pump	Electric type.

CHASSIS

Structure	High strength flanged 'u' section.
Chassis Options:	
Dozer Blade	Front or rear pin mount.
Stabilisers	Front or rear pin mount, independently operable – plus combinations.
Grab Stowage	Heavy duty, pin mounted stowage bar.
Transmission	Hydrostatic drive via piston motor and powershift transmission.
Travel speed	Creep speed 3.8kph (2.4mph) Low ratio 8.1kph (5mph) High ratio 25kph (15.5mph)
Drawbar pull	99.7kN
Axles	Four wheel drive. Front steering axle oscillates for rough ground mobility.
Axle load capacity	32 tonnes
Axle oscillation	+/- 8.5 degrees
Ground clearance	350mm (1ft 2in)
Steering	Fully hydraulic system.
Turning radius	
To outside of tyres	5.45m (17ft 10in)
To outer edge of front mounted dozer blade	6.06m (19ft 10in)
Brakes	All hydraulic, dual circuit brake system.
Parking Brake	Built into the transmission.

SWING SYSTEM

Drive train	Axial piston motor and planetary reduction final drive.
Swing brake	Hydraulic braking plus automatic spring applied disc type parking brake.
Swing speed	10.4RPM
Swing gear	Large diameter, internally toothed fully sealed grease bath lubricated.
Swing lock	Multi position switchable brake and mechanical lock.

EXCAVATOR END

Monoboom available along with a choice of dipper lengths to suit the requirements of reach, dig-depth, loadover height, tearouts and site versatility. Reserve strength is built into the fully welded structures for hydraulic hammer and other arduous operations. Fabricated bucket tipping links are provided with a choice of lift points. Strong, durable construction, large cross sections and multi plate fabrications to withstand high stress applications. The 5.15m (16ft 11in) boom is designed to ensure the optimum digging envelope when matched with the three dipper lengths. Low maintenance bronze alloy bushes with graphite plugs are fitted to boom base and boom to dipper pivots resulting in 1000 hour greasing intervals at these points.



MAIN HYDRAULIC SYSTEM

System	Load-sensed hydraulic system with twin variable flow piston pumps providing flow-on-demand for maximum efficiency.
Main pumps	2 variable displacement axial piston type
Maximum flow	2 x 138 l/min (30 UK gpm)
Main circuit pressure	314 bar (4555 lb/in ²)
With power boost	343 bar (4975 lb/in ²)
Servo pump	Gear type
Maximum flow	22 l/min (5 UK gpm)
Servo pressure	40 bar (580 lb/in ²)
Optional Circuits:	
Hammer	Includes automatic engine speed setting and return filter.
Maximum flow	138 l/min (30 UK gpm)
Maximum pressure	314 (343) bar (4555/4975 lb/in ²) (pre-set to 180 bar (2610 lb/in ²))
Grab operation	
Maximum flow	138 l/min (30 UK gpm)
Maximum pressure for grab ram operation	314 (343) bar (4555/4975 lb/in ²)
Hydraulic Cylinders	With hardened, chromed piston rods and end cushioning on boom, dipper and bucket crowd cylinder.
Filtration	
In tank	150 micron, suction strainer.
Main return line	10 micron, fibreform element.
Pilot line	10 micron, paper element.
Nephron by pass line	1.5 micron paper element.
Hydraulic hammer return	10 micron, reinforced microform element.

TYRES

Twins	10.00 x 20 tyres (16PR) with spacer ring.
Singles	18R x 19.5 tyres (Radials).

CAB

Excellent digging, loading and positioning visibility results from the careful design of front, side and roof lights. All screens are tinted to improve in cab conditions.

Fully opening front screen is very smooth to operate and as the lower screen is stored easily and discreetly behind the operator in the rear window bay.

Fresh air ventilation available from opening door window, opening slot in front screen and fully opening front screen.

Parallelogram wash wiper for upper screen ensuring good wiped area for maximum visibility. Wiper motor is fitted in the left hand side of the roof screen so as not to affect bucket visibility when loading. Optional lower screen wiper available.

Fresh air ventilation and heater with windscreen demister. Infinitely variable blower speed, temperature and recirculation control.

Climate control incorporating chilled cool box available as option. Fully adjustable deluxe suspension seat with arm rest adjustment and backrest recline. Radio with digital tuner fitted into the roof lining for maximum protection. Conveniently placed radio mute button incorporated into lower console. 12v power point and mobile phone holder built into the right hand console. Courtesy light can be operated from ground level and is illuminated for five minutes or until switched off improving operator access at night.

Roof mounted roller blind protects operator from the suns glare through the top screen.



AMS – ADVANCED MANAGEMENT SYSTEM

Four selectable working modes link the operators control movements with the engine and hydraulic systems to maximise productivity and efficiency.

- A (Auto)** Up to 100% engine power and 100% flow. Gives variable power and speed depending on the operator's input, matching the demand for output and efficiency to the job. Power boost is automatically activated in this mode should hard conditions be encountered. Auto idle cuts in after a period of inactivity (between 5 and 30 seconds as set by the operator)
- E (Economy)** 80% engine power. 95% of hydraulic flow maximises economy while maintaining excellent output.
- P (Precision)** 55% engine power. 90% of hydraulic flow for fine control of grading operations.
- L (Lifting)** 55% engine power. 63% of hydraulic flow with permanent power boost for maximum lifting power and control.

The Auto mode allows the AMS processor to select the optimum operational performance to match the demands of the job while the three alternative modes give precise matching of application when specific tasks are undertaken.

The adjustable position monitor mounted on the front right hand pillar of the cab gives the operator a constant read out of mode, tracking range, operating temperature and a host of other information, while retaining excellent visibility of the monitor and the job being carried out.

The required flow for hammer applications can be set and stored in the AMS memory and is automatically activated whenever the hammer pedal is depressed.

A maintenance indicator warns of imminent service needs, and all servicing and basic checks can be carried out using only the in cab display.

STANDARD EXCAVATING BUCKETS

All buckets are JCB – Esco fully welded steel, with sealed, hardened steel pivot pins and replaceable wear parts.

Max Width mm (in.)	Capacity (SAE heaped) cu.m (cu.yd)	Weight kg (lb)
600 (24)	0.35 (0.46)	426 (937)
750 (30)	0.49 (0.64)	480 (1056)
900 (36)	0.62 (0.81)	525 (1155)
1000 (40)	0.72 (0.94)	564 (1240)
1200 (48)	0.90 (1.18)	633 (1392)

SERVICE CAPACITIES

	litres	UK gal
Fuel tank	310	56
Engine coolant	19.5	3.6
Engine oil	20.4	3.2
Swing reduction gear	6	0.5
Hydraulic system	124	27.3
Hydraulic tank	73	16.0
Transmission	2.5	0.7
Axle differentials (each)	Rear 12, Front 14	Rear 2.6, Front 3
Axle hubs (each)	2.0	0.5





STANDARD EQUIPMENT

Engine fan guard; Cold start pre-heat; Auto engine warm up; Double element air cleaner; Heavy duty alternator; Electrics isolator; Heavy duty batteries; Cab & engine soundproofing; Cab heater & screen demister; Tinted glass; Interior light; Coat hook; Ashtray; Operator's storage box; Removable floor mat; Windscreen wash/wipe; Plug-in power socket; Automatic power boost; Auto-idle; One-touch engine speed control; Hydraulic cushion control; Plexus hydraulic oil filtration; HSP pressure test points; Auxiliary pipework mounting brackets; Work lights – boom & mainframe mounted; Upper structure under covers; Swing system cover; External mirrors; Handrail & non slip walk ways;

OPTIONAL EQUIPMENT

Hose burst check valves & overload warning system; Tipping link mounted lift points; General purpose buckets; Ditch/grading buckets; Quickhitch buckets; Hydraulic hammers; Auxiliary pipework (full and low flow); Air conditioning or climate control; Cab mounted & rear work lights; Rotating beacon; Rain guard; Biodegradable oil; Air suspension seat with heated pad and lumbar support adjustment; Electric refuelling pump; Lower screen wiper; Radio cassette player; Cruise control. FOPS (Level 2) operator protection; ROPS cab; immobiliser; LiveLink; HRC; Proportional control; Widecore cooling pack; Rear view camera; 2F axles hub brakes; 2F axles wide hub brakes.

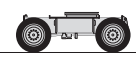
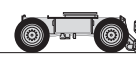
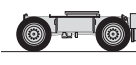
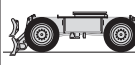
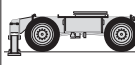
OPERATING WEIGHTS

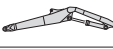
Chassis					
	15560kg (34304lb)	16000kg (35274lb)	16440kg (36244lb)	16980kg (37434lb)	17320kg (38184lb)
	16160kg (35627lb)	16600kg (36597lb)	17040kg (37567lb)	17580kg (38757lb)	17820kg (39286lb)

Machine equipped with excavating bucket and dual wheels. For single wheels subtract 400kg (880lb).

LIFT CAPACITIES – Dipper Length: 2.25m, 5.15m Monoboom, Rear dozer, No bucket.
JS160W MONO

Reach	1.5m (4ft 11in)		3m (9ft 10in)		4.5m (14ft 9in)		6m (19ft 8in)		7.5m (24ft 7in)		Capacity at Max Reach			
													mm	
Load Point Ht.	kg	kg	kg	kg	kg	kg	kg	kg	kg	kg	kg	kg	mm	
7.5m (24.7ft)					4360*	4360*						3830*	3830*	4620
6.0m (19.8ft)					5080*	4470	3530*	2760				3330*	2740	6031
4.5m (14.9ft)					5710*	4260	4890*	2730				3190*	2190	6838
3.0m (9.10ft)					6740*	3940	5250*	2600				3230*	1940	7248
1.5m (4.11ft)					7530*	3650	5580*	2470				3440*	1850	7330
0m			5580*	5580*	7600*	3510	5600*	2380				3880*	1910	7094
- 1.5m (- 4.11ft)	6310*	6310*	9440*	6460	6950*	3490	5060*	2370				4400*	2150	6508
- 3.0m (- 9.10ft)	8760*	8760*	7190*	6620	5360*	3580						4000*	2790	5454
- 4.5m (- 14.9ft)			2810*	2810*								2280*	2280*	3524

LIFT CAPACITIES – Dipper Length: 2.70m, 5.15m Monoboom, Rear dozer, No bucket.
JS160W MONO

Reach	1.5m (4ft 11in)		3m (9ft 10in)		4.5m (14ft 9in)		6m (19ft 8in)		7.5m (24ft 7in)		Capacity at Max Reach			
													mm	
Load Point Ht.	kg	kg	kg	kg	kg	kg	kg	kg	kg	kg	kg	kg	mm	
7.5m (24.7ft)												2880*	2880*	5238
6.0m (19.8ft)							4040*	2860				2580*	2460	6514
4.5m (14.9ft)					5290*	4370	4610*	2780				2500*	2010	7266
3.0m (9.10ft)			9710*	7300	6360*	4010	5040*	2630	3370*	1860		2540*	1800	7653
1.5m (4.11ft)			5120*	5120*	7290*	3680	5450*	2480	4100*	1800		2690*	1710	7731
0m			6660*	6250	7590*	3480	5600*	2360	3080*	1750		3020*	1750	7508
- 1.5m (- 4.11ft)	6070*	6070*	10140*	6280	7170*	3420	5280*	2320				3630*	1930	6957
- 3.0m (- 9.10ft)	10160*	10160*	8130*	6430	5930*	3480						4020*	2400	5985
- 4.5m (- 14.9ft)			4570*	4570*								3120*	3120*	4307

LIFT CAPACITIES – Dipper Length: 3.05m, 5.15m Monoboom, Rear dozer, No bucket.
JS160W MONO

Reach	1.5m (4ft 11in)		3m (9ft 10in)		4.5m (14ft 9in)		6m (19ft 8in)		7.5m (24ft 7in)		Capacity at Max Reach			
													mm	
Load Point Ht.	kg	kg	kg	kg	kg	kg	kg	kg	kg	kg	kg	kg	mm	
7.5m (24.7ft)												2400*	2400*	5690
6.0m (19.8ft)							3840*	2860				2170*	2170	6881
4.5m (14.9ft)							4350*	2780	2500*	1890		2110*	1840	7596
3.0m (9.10ft)			8930*	7540	6020*	4060	4830*	2630	3790*	1840		2150*	1650	7967
1.5m (4.11ft)			6790*	6590	7070*	3700	5300*	2460	4270	1760		2280*	1580	8041
0m			6950*	6270	7540*	3470	5540*	2340	4200	1710		2540*	1600	7828
- 1.5m (- 4.11ft)	5610*	5610*	9860*	6240	7290*	3390	5350*	2280				3040*	1760	7301
- 3.0m (- 9.10ft)	9050*	9050*	8780*	6350	6260*	3420	4430*	2310				3920*	2140	6383
- 4.5m (- 14.9ft)	7560*	7560*	5630*	5630*	3860*	3600						3340*	3260	4849

Lift capacity front and rear.

Lift capacity full circle.

Notes:

- For lifting capacity including bucket, subtract total weight of bucket or bucket and quickhitch from above values.
- Lifting capacities are based on ISO 10567, that is: 75% of minimum tipping load or 87% of hydraulic lift capacity, whichever is the less. Lifting capacities marked* are based on hydraulic capacity.
- Lift capacities assume that the machine is on firm, level ground.
- Lift capacities may be limited by local regulations. Please refer to your dealer.

LIFT CAPACITIES – Dipper Length: 2.25m, 5.15m Monoboom, Rear stabilisers, No bucket.
JS160W MONO

Reach	1.5m (4ft 11in)		3m (9ft 10in)		4.5m (14ft 9in)		6m (19ft 8in)		7.5m (24ft 7in)		Capacity at Max Reach			
													kg	kg
Load Point Ht.	kg	kg	kg	kg	kg	kg	kg	kg	kg	kg	kg	kg	kg	mm
7.5m (24.7ft)					4360*	4360*						3830*	3830*	4620
6.0m (19.8ft)					5080*	5080*	3530*	3260				3330*	3230	6031
4.5m (14.9ft)					5710*	5050	4890*	3220				3190*	2590	6838
3.0m (9.10ft)					6740*	4710	4980	3090				3230*	2310	7248
1.5m (4.11ft)					7530*	4420	4830	2950				3440*	2220	7330
0m			5580*	5580*	7450	4260	4730	2860				3710	2290	7094
- 1.5m (- 4.11ft)	6310*	6310*	9440*	8090	6950*	4240	4720	2850				4200	2570	6508
- 3.0m (- 9.10ft)	8760*	8760*	7190*	7190*	5360*	4340						4000*	3350	5454
- 4.5m (- 14.9ft)			2810*	2810*								2280*	2280*	3524

LIFT CAPACITIES – Dipper Length: 2.70m, 5.15m Monoboom, Rear stabilisers, No bucket.
JS160W MONO

Reach	1.5m (4ft 11in)		3m (9ft 10in)		4.5m (14ft 9in)		6m (19ft 8in)		7.5m (24ft 7in)		Capacity at Max Reach			
													kg	kg
Load Point Ht.	kg	kg	kg	kg	kg	kg	kg	kg	kg	kg	kg	kg	kg	mm
7.5m (24.7ft)												2880*	2880*	5238
6.0m (19.8ft)							4040*	3350				2580*	2580*	6514
4.5m (14.9ft)					5290*	5160	4610*	3280				2500*	2380	7266
3.0m (9.10ft)			9710*	9010	6360*	4790	5030	3120	3370*	2210		2540*	2140	7653
1.5m (4.11ft)			5120*	5120*	7290*	4440	4850	2960	3460	2150		2690*	2050	7731
0m			6660*	6660*	7420	4230	4720	2850	3080*	2110		3020*	2100	7508
- 1.5m (- 4.11ft)	6070*	6070*	10140*	7900	7170*	4170	4670	2810				3630*	2320	6957
- 3.0m (- 9.10ft)	10160*	10160*	8130*	8060	5930*	4240						4020*	2890	5985
- 4.5m (- 14.9ft)			4570*	4570*								3120*	3120*	4307

LIFT CAPACITIES – Dipper Length: 3.05m, 5.15m Monoboom, Rear stabilisers, No bucket.
JS160W MONO

Reach	1.5m (4ft 11in)		3m (9ft 10in)		4.5m (14ft 9in)		6m (19ft 8in)		7.5m (24ft 7in)		Capacity at Max Reach			
													kg	kg
Load Point Ht.	kg	kg	kg	kg	kg	kg	kg	kg	kg	kg	kg	kg	kg	mm
7.5m (24.7ft)												2400*	2400*	5690
6.0m (19.8ft)							3840*	3360				2170*	2170*	6881
4.5m (14.9ft)							4350*	3270	2500*	2250		2110*	2110*	7596
3.0m (9.10ft)			8930*	8930*	6020*	4840	4830*	3120	3510	2190		2150*	1980	7967
1.5m (4.11ft)			6790*	6790*	7070*	4470	4840	2950	3430	2120		2280*	1800	8041
0m			6950*	6950*	7430	4230	4649	2820	3360	2060		2540*	1940	7828
- 1.5m (- 4.11ft)	5610*	5610*	9860*	7860	7290*	4140	4620	2760				3040*	2120	7301
- 3.0m (- 9.10ft)	9050*	9050*	8780*	7990	6260*	4170	4430*	2790				3920*	2590	6383
- 4.5m (- 14.9ft)	7560*	7560*	5630*	5630*	3860*	3860*						3340*	3340*	4849



Lift capacity front and rear.



Lift capacity full circle.

Notes:

- For lifting capacity including bucket, subtract total weight of bucket or bucket and quickhitch from above values.
- Lifting capacities are based on ISO 10567, that is: 75% of minimum tipping load or 87% of hydraulic lift capacity, whichever is the less. Lifting capacities marked* are based on hydraulic capacity.
- Lift capacities assume that the machine is on firm, level ground.
- Lift capacities may be limited by local regulations. Please refer to your dealer.

LIFT CAPACITIES – Dipper Length: 2.25m, 5.15m Monoboom, Front dozer, Rear stabilisers, No bucket.
JS160W MONO

Reach	1.5m (4ft 11in)		3m (9ft 10in)		4.5m (14ft 9in)		6m (19ft 8in)		7.5m (24ft 7in)		Capacity at Max Reach			
													kg	kg
Load Point Ht.	kg	kg	kg	kg	kg	kg	kg	kg	kg	kg	kg	kg	kg	mm
7.5m (24.7ft)					4360*	4360*						3830*	3830*	4620
6.0m (19.8ft)					5080*	5080*	3530*	3530*				3330*	3330*	6031
4.5m (14.9ft)					5710*	5710*	4890*	4110				3190*	3090*	6838
3.0m (9.10ft)					6740*	6160	5250*	3970				3230*	2980	7248
1.5m (4.11ft)					7530*	5830	5580*	3830				3440*	2870	7330
0m			5580*	5580*	7600*	5670	5600*	3740				3880*	2970	7094
- 1.5m (- 4.11ft)	6310*	6310*	9440*	9440*	6950*	5650	5060*	3730				4400*	3350	6508
- 3.0m (- 9.10ft)	8760*	8760*	7190*	7190*	5360*	5360*						4000*	4000*	5454
- 4.5m (- 14.9ft)			2810*	2810*								2280*	2280*	3524

LIFT CAPACITIES – Dipper Length: 2.70m, 5.15m Monoboom, Front dozer, Rear stabilisers, No bucket.
JS160W MONO

Reach	1.5m (4ft 11in)		3m (9ft 10in)		4.5m (14ft 9in)		6m (19ft 8in)		7.5m (24ft 7in)		Capacity at Max Reach			
													kg	kg
Load Point Ht.	kg	kg	kg	kg	kg	kg	kg	kg	kg	kg	kg	kg	kg	mm
7.5m (24.7ft)												2880*	2880*	5238
6.0m (19.8ft)							4040*	4040*				2580*	2580*	6514
4.5m (14.9ft)					5290*	5290*	4610*	4170				2500*	2500*	7266
3.0m (9.10ft)			9710*	9710*	6360*	6240	5040*	4010	3370*	2850		2540*	2540*	7653
1.5m (4.11ft)			5120*	5120*	7290*	5860	5450*	3840	4100*	2780		2690*	2660	7731
0m			6660*	6660*	7590*	5640	5600*	3720	3080*	2740		3020*	2730	7508
- 1.5m (- 4.11ft)	6070*	6070*	10140*	10140*	7170*	5570	5280*	3680				3630*	3030	6957
- 3.0m (- 9.10ft)	10160*	10160*	8130*	8130*	5930*	5640						4020*	3770	5985
- 4.5m (- 14.9ft)			4570*	4570*								3120*	3120*	4307

LIFT CAPACITIES – Dipper Length: 3.05m, 5.15m Monoboom, Front dozer, Rear stabilisers, No bucket.
JS160W MONO

Reach	1.5m (4ft 11in)		3m (9ft 10in)		4.5m (14ft 9in)		6m (19ft 8in)		7.5m (24ft 7in)		Capacity at Max Reach			
													kg	kg
Load Point Ht.	kg	kg	kg	kg	kg	kg	kg	kg	kg	kg	kg	kg	kg	mm
7.5m (24.7ft)												2400*	2400*	5690
6.0m (19.8ft)							3840*	3840*				2170*	2170*	6881
4.5m (14.9ft)							4350*	4170	2500*	2500*		2110*	2110*	7596
3.0m (9.10ft)			8930*	8930*	6020*	6020*	4830*	4010	3790*	2830		2150*	2150*	7967
1.5m (4.11ft)			6790*	6790*	7070*	5900	5300*	3830	4330*	2750		2280*	2280*	8041
0m			6950*	6950*	7540*	5640	5540*	3700	4320*	2690		2540*	2530	7828
- 1.5m (- 4.11ft)	5610*	5610*	9860*	9860*	7290*	5540	5350*	3630				3040*	2780	7301
- 3.0m (- 9.10ft)	9050*	9050*	8780*	8780*	6260*	5580	4430*	3670				3920*	3380	6383
- 4.5m (- 14.9ft)	7560*	7560*	5630*	5630*	3860*	3860*						3340*	3340*	4849



Lift capacity front and rear.



Lift capacity full circle.

Notes:

- For lifting capacity including bucket, subtract total weight of bucket or bucket and quickhitch from above values.
- Lifting capacities are based on ISO 10567, that is: 75% of minimum tipping load or 87% of hydraulic lift capacity, whichever is the less. Lifting capacities marked* are based on hydraulic capacity.
- Lift capacities assume that the machine is on firm, level ground.
- Lift capacities may be limited by local regulations. Please refer to your dealer.

LIFT CAPACITIES – Dipper Length: 2.25m, 5.15m Monoboom, Front stabilisers, Rear stabilisers, No bucket.
JS160W MONO

Reach	1.5m (4ft 11in)		3m (9ft 10in)		4.5m (14ft 9in)		6m (19ft 8in)		7.5m (24ft 7in)		Capacity at Max Reach			
													mm	
Load Point Ht.	kg	kg	kg	kg	kg	kg	kg	kg	kg	kg	kg	kg	mm	
7.5m (24.7ft)					4360*	4360*						3830*	3830*	4620
6.0m (19.8ft)					5080*	5080*	3530*	3530*				3330*	3330*	6031
4.5m (14.9ft)					5710*	5710*	4890*	4670				3190*	3190*	6838
3.0m (9.10ft)					6740*	6740*	5250*	4520				3230*	3230*	7248
1.5m (4.11ft)					7530*	6750	5580*	4380				3440*	3270	7330
0m			5580*	5580*	7600*	6580	5600*	4280				3880*	3390	7094
- 1.5m (- 4.11ft)	6310*	6310*	9440*	9440*	6950*	6550	5060*	4270				4400*	3830	6508
- 3.0m (- 9.10ft)	8760*	8760*	7190*	7190*	5360*	5360*						4000*	4000*	5454
- 4.5m (- 14.9ft)			2810*	2810*								2280*	2280*	3524

LIFT CAPACITIES – Dipper Length: 2.70m, 5.15m Monoboom, Front stabilisers, Rear stabilisers, No bucket.
JS160W MONO

Reach	1.5m (4ft 11in)		3m (9ft 10in)		4.5m (14ft 9in)		6m (19ft 8in)		7.5m (24ft 7in)		Capacity at Max Reach			
													mm	
Load Point Ht.	kg	kg	kg	kg	kg	kg	kg	kg	kg	kg	kg	kg	mm	
7.5m (24.7ft)												2880*	2880*	5238
6.0m (19.8ft)							4040*	4040*				2580*	2580*	6514
4.5m (14.9ft)					5290*	5290*	4610*	4610*				2500*	2500*	7266
3.0m (9.10ft)			9710*	9710*	6360*	6360*	5040*	4570	3370*	3240		2540*	2540*	7653
1.5m (4.11ft)			5120*	5120*	7290*	6780	5450*	4390	4100*	3170		2690*	2690*	7731
0m			6660*	6660*	7590*	6550	5600*	4270	3080*	3080		3020*	3020	7508
- 1.5m (- 4.11ft)	6070*	6070*	10140*	10140*	7170*	6480	5280*	4220				3630*	3460	6957
- 3.0m (- 9.10ft)	10160*	10160*	8130*	8130*	5930*	5930*						4020*	4020*	5985
- 4.5m (- 14.9ft)			4570*	4570*								3120*	3120*	4307

LIFT CAPACITIES – Dipper Length: 3.05m, 5.15m Monoboom, Front stabilisers, Rear stabilisers, No bucket.
JS160W MONO

Reach	1.5m (4ft 11in)		3m (9ft 10in)		4.5m (14ft 9in)		6m (19ft 8in)		7.5m (24ft 7in)		Capacity at Max Reach			
													mm	
Load Point Ht.	kg	kg	kg	kg	kg	kg	kg	kg	kg	kg	kg	kg	mm	
7.5m (24.7ft)												2400*	2400*	5690
6.0m (19.8ft)							3840*	3840*				2170*	2170*	6881
4.5m (14.9ft)							4350*	4350*	2500*	2500*		2110*	2110*	7596
3.0m (9.10ft)			8930*	8930*	6020*	6020*	4830*	4560	3790*	3220		2150*	2150*	7967
1.5m (4.11ft)			6790*	6790*	7070*	6820	5300*	4380	4330*	3140		2280*	2280*	8041
0m			6950*	6950*	7540*	6550	5540*	4240	4320*	3070		2540*	2540*	7828
- 1.5m (- 4.11ft)	5610*	5610*	9860*	9860*	7290*	6450	5350*	4180				3040*	3040*	7301
- 3.0m (- 9.10ft)	9050*	9050*	8780*	8780*	6260*	6260*	4430*	4210				3920*	3880	6383
- 4.5m (- 14.9ft)	7560*	7560*	5630*	5630*	3860*	3860*						3340*	3340*	4849



Lift capacity front and rear.



Lift capacity full circle.

Notes:

- For lifting capacity including bucket, subtract total weight of bucket or bucket and quickhitch from above values.
- Lifting capacities are based on ISO 10567, that is: 75% of minimum tipping load or 87% of hydraulic lift capacity, whichever is the less. Lifting capacities marked* are based on hydraulic capacity.
- Lift capacities assume that the machine is on firm, level ground.
- Lift capacities may be limited by local regulations. Please refer to your dealer.

LIFT CAPACITIES – Dipper Length: 2.25m, 4.97m T.A.B., Rear dozer, No bucket.
JSI60W T.A.B.

Reach	1.5m (4ft 11in)		3m (9ft 10in)		4.5m (14ft 9in)		6m (19ft 8in)		7.5m (24ft 7in)		Capacity at Max Reach			
													kg	kg
Load Point Ht.	kg	kg	kg	kg	kg	kg	kg	kg	kg	kg	kg	kg	kg	mm
7.5m (24.7ft)												4240*	4240*	4492
6.0m (19.8ft)					4690*	4560						3510*	2810	5935
4.5m (14.9ft)			6720*	6720*	5250*	4360	4630*	2750				3270*	2230	6753
3.0m (9.10ft)					6270*	4020	4990*	2630				3230*	1970	7168
1.5m (4.11ft)					7190*	3700	5390*	2480				3350*	1880	7251
0m			5340*	5340*	7530*	3520	5540*	2390				3670*	1940	7013
- 1.5m (- 4.11ft)			10110*	6460	7130*	3500	5140*	2380				4330*	2200	6419
- 3.0m (- 9.10ft)					5670*	3610						5100*	3240	4882

LIFT CAPACITIES – Dipper Length: 2.70m, 4.97m T.A.B., Rear dozer, No bucket.
JSI60W T.A.B.

Reach	1.5m (4ft 11in)		3m (9ft 10in)		4.5m (14ft 9in)		6m (19ft 8in)		7.5m (24ft 7in)		Capacity at Max Reach				
													kg	kg	mm
Load Point Ht.	kg	kg	kg	kg	kg	kg	kg	kg	kg	kg	kg	kg	kg	mm	
7.5m (24.7ft)					4410*	4410*							3120*	3120*	5155
6.0m (19.8ft)					4240*	4240*	4170*	2880					2700*	2500	6448
4.5m (14.9ft)					4820*	4480	4330*	2820					2550*	2040	7207
3.0m (9.10ft)			8730*	7550	5870*	4110	4750*	2670	3200*	1860			2530*	1810	7597
1.5m (4.11ft)					6900*	3730	5220*	2500	3880*	1800			2630*	1730	7675
0m			6410*	6280	7430*	3500	5490*	2380					2870*	1770	7451
- 1.5m (- 4.11ft)			10500*	6290	7270*	3430	5330*	2330					3340*	1970	6895
- 3.0m (- 9.10ft)			8830*	6460	6230*	3500							4150*	2480	5913

LIFT CAPACITIES – Dipper Length: 3.05m, 4.97m T.A.B., Rear dozer, No bucket.
JSI60W T.A.B.

Reach	1.5m (4ft 11in)		3m (9ft 10in)		4.5m (14ft 9in)		6m (19ft 8in)		7.5m (24ft 7in)		Capacity at Max Reach				
													kg	kg	mm
Load Point Ht.	kg	kg	kg	kg	kg	kg	kg	kg	kg	kg	kg	kg	kg	mm	
7.5m (24.7ft)													2580*	2580*	5629
6.0m (19.8ft)							3860*	2900					2270*	2250	6831
4.5m (14.9ft)					4440*	4440*	4050*	2820	2430*	1880			2150*	1860	7551
3.0m (9.10ft)			7950*	7800	5520*	4150	4520*	2670	3790*	1840			2140*	1660	7924
1.5m (4.11ft)			6890*	6730	6650*	3760	5040*	2490	4210*	1770			2230*	1590	7998
0m			6710*	6310	7320*	3500	5400*	2350	4210*	1710			2420*	1620	7784
- 1.5m (- 4.11ft)	5120*	5120*	9850*	6250	7330*	3400	5370*	2290					2800*	1790	7254
- 3.0m (- 9.10ft)			9410*	6380	6530*	3430	4540*	2330					3590*	2200	6329

Lift capacity front and rear.

Lift capacity full circle.

Notes:

1. For lifting capacity including bucket, subtract total weight of bucket or bucket and quickhitch from above values.
2. Lifting capacities are based on ISO 10567, that is: 75% of minimum tipping load or 87% of hydraulic lift capacity, whichever is the less. Lifting capacities marked* are based on hydraulic capacity.
3. Lift capacities assume that the machine is on firm, level ground.
4. Lift capacities may be limited by local regulations. Please refer to your dealer.

LIFT CAPACITIES – Dipper Length: 2.25m, 4.97m T.A.B., Rear stabilisers, No bucket.
JSI60W T.A.B.

Reach	1.5m (4ft 11in)		3m (9ft 10in)		4.5m (14ft 9in)		6m (19ft 8in)		7.5m (24ft 7in)		Capacity at Max Reach				
													kg	kg	mm
Load Point Ht.	kg	kg	kg	kg	kg	kg	kg	kg	kg	kg	kg	kg	kg	mm	
7.5m (24.7ft)													4240*	4240*	4492
6.0m (19.8ft)					4690*	4690*							3510*	3330	5935
4.5m (14.9ft)			6720*	6720*	5250*	5170	4630*	3260					3270*	2660	6753
3.0m (9.10ft)					6270*	4810	4990*	3130					3230*	2360	7168
1.5m (4.11ft)					7190*	4480	4930	2980					3350*	2260	7251
0m			5340*	5340*	7530*	4300	4820	2890					3670*	2340	7013
- 1.5m (- 4.11ft)			10110*	8130	7130*	4270	4810	2880					4330*	2650	6419
- 3.0m (- 9.10ft)					5670*	4390							5100*	3920	4882

LIFT CAPACITIES – Dipper Length: 2.70m, 4.97m T.A.B., Rear stabilisers, No bucket.
JSI60W T.A.B.

Reach	1.5m (4ft 11in)		3m (9ft 10in)		4.5m (14ft 9in)		6m (19ft 8in)		7.5m (24ft 7in)		Capacity at Max Reach				
													kg	kg	mm
Load Point Ht.	kg	kg	kg	kg	kg	kg	kg	kg	kg	kg	kg	kg	kg	mm	
7.5m (24.7ft)					4410*	4410*							3120*	3120*	5155
6.0m (19.8ft)					4240*	4240*	4170*	3400					2700*	2700*	6448
4.5m (14.9ft)					4820*	4820*	4330*	3330					2550*	2430	7207
3.0m (9.10ft)			8730*	8730*	5870*	4910	4750*	3180	3200*	2220			2530*	2170	7597
1.5m (4.11ft)					6900*	4520	4960	3000	3520	2160			2630*	2090	7675
0m			6410*	6410*	7430*	4280	4810	2870					2870*	2140	7451
- 1.5m (- 4.11ft)			10500*	7950	7270*	4200	4760	2830					3340*	2380	6895
- 3.0m (- 9.10ft)			8830*	8140	6230*	4280							4150*	2990	5913

LIFT CAPACITIES – Dipper Length: 3.05m, 4.97m T.A.B., Rear stabilisers, No bucket.
JSI60W T.A.B.

Reach	1.5m (4ft 11in)		3m (9ft 10in)		4.5m (14ft 9in)		6m (19ft 8in)		7.5m (24ft 7in)		Capacity at Max Reach				
													kg	kg	mm
Load Point Ht.	kg	kg	kg	kg	kg	kg	kg	kg	kg	kg	kg	kg	kg	mm	
7.5m (24.7ft)													2580*	2580*	5629
6.0m (19.8ft)							3860*	3420					2270*	2270*	6831
4.5m (14.9ft)					4440*	4440*	4050*	3340	2430*	2250			2150*	2150*	7551
3.0m (9.10ft)			7950*	7950*	5520*	4960	4520*	3180	3580	2210			2140*	2000	7924
1.5m (4.11ft)			6890*	6890*	6650*	4550	4950	2990	3490	2130			2230*	1920	7998
0m			6710*	6710*	7320*	4280	4790	2850	3430	2070			2420*	1970	7784
- 1.5m (- 4.11ft)	5120*	5120*	9850*	7920	7330*	4170	4710	2780					2800*	2170	7254
- 3.0m (- 9.10ft)			9410*	8050	6530*	4210	4540*	2830					3590*	2660	6329

Lift capacity front and rear.

Lift capacity full circle.

Notes:

1. For lifting capacity including bucket, subtract total weight of bucket or bucket and quickhitch from above values.
2. Lifting capacities are based on ISO 10567, that is: 75% of minimum tipping load or 87% of hydraulic lift capacity, whichever is the less. Lifting capacities marked* are based on hydraulic capacity.
3. Lift capacities assume that the machine is on firm, level ground.
4. Lift capacities may be limited by local regulations. Please refer to your dealer.

LIFT CAPACITIES – Dipper Length: 2.25m, 4.97m T.A.B., Front dozer, Rear stabilisers, No bucket.
JSI60W T.A.B.

Reach	1.5m (4ft 11in)		3m (9ft 10in)		4.5m (14ft 9in)		6m (19ft 8in)		7.5m (24ft 7in)		Capacity at Max Reach			
													kg	kg
Load Point Ht.	kg	kg	kg	kg	kg	kg	kg	kg	kg	kg	kg	kg	kg	mm
7.5m (24.7ft)												4240*	4240*	4492
6.0m (19.8ft)					4690*	4690*						3510*	3510*	5935
4.5m (14.9ft)			6720*	6720*	5250*	5250*	4630*	4180				3270*	3270*	6753
3.0m (9.10ft)					6270*	6270*	4990*	4040				3230*	3050	7168
1.5m (4.11ft)					7190*	5940	5390*	3890				3350*	2950	7251
0m			5340*	5340*	7530*	5750	5540*	3790				3670*	3060	7013
- 1.5m (- 4.11ft)			10110*	10110*	7130*	5710	5140*	3780				4330*	3470	6419
- 3.0m (- 9.10ft)					5670*	5670*						5100*	5100*	4882

LIFT CAPACITIES – Dipper Length: 2.70m, 4.97m T.A.B., Front dozer, Rear stabilisers, No bucket.
JSI60W T.A.B.

Reach	1.5m (4ft 11in)		3m (9ft 10in)		4.5m (14ft 9in)		6m (19ft 8in)		7.5m (24ft 7in)		Capacity at Max Reach			
													kg	kg
Load Point Ht.	kg	kg	kg	kg	kg	kg	kg	kg	kg	kg	kg	kg	kg	mm
7.5m (24.7ft)					4410*	4410*						3120*	3120*	5155
6.0m (19.8ft)					4240*	4240*	4170*	4170*				2700*	2700*	6448
4.5m (14.9ft)					4820*	4820*	4330*	4260				2550*	2550*	7207
3.0m (9.10ft)			8730*	8730*	5870*	5870*	4750*	4090	3200*	2880		2530*	2530*	7597
1.5m (4.11ft)					6900*	5980	5220*	3910	3880*	2810		2630*	2630*	7675
0m			6410*	6410*	7430*	5720	5490*	3770				2870*	2800	7451
- 1.5m (- 4.11ft)			10500*	10500*	7270*	5640	5330*	3730				3340*	3110	6895
- 3.0m (- 9.10ft)			8830*	8830*	6230*	5720						4150*	3910	5913

LIFT CAPACITIES – Dipper Length: 3.05m, 4.97m T.A.B., Front dozer, Rear stabilisers, No bucket.
JSI60W T.A.B.

Reach	1.5m (4ft 11in)		3m (9ft 10in)		4.5m (14ft 9in)		6m (19ft 8in)		7.5m (24ft 7in)		Capacity at Max Reach			
													kg	kg
Load Point Ht.	kg	kg	kg	kg	kg	kg	kg	kg	kg	kg	kg	kg	kg	mm
7.5m (24.7ft)												2580*	2580*	5629
6.0m (19.8ft)							3860*	3860*				2270*	2270*	6831
4.5m (14.9ft)					4440*	4440*	4050*	4050*	2430*	2430*		2150*	2150*	7551
3.0m (9.10ft)			7950*	7950*	5520*	5520*	4520*	4090	3790*	2870		2140*	2140*	7924
1.5m (4.11ft)			6890*	6890*	6650*	6020	5040*	3900	4210*	2790		2230*	2230*	7998
0m			6710*	6710*	7320*	5730	5400*	3750	4210*	2720		2420*	2420*	7784
- 1.5m (- 4.11ft)	5120*	5120*	9850*	9850*	7330*	5610	5370*	3680				2800*	2800*	7254
- 3.0m (- 9.10ft)			9410*	9410*	6530*	5650	4540*	3730				3590*	3490	6329

Lift capacity front and rear.
 Lift capacity full circle.

- Notes:**
- For lifting capacity including bucket, subtract total weight of bucket or bucket and quickhitch from above values.
 - Lifting capacities are based on ISO 10567, that is: 75% of minimum tipping load or 87% of hydraulic lift capacity, whichever is the less. Lifting capacities marked* are based on hydraulic capacity.
 - Lift capacities assume that the machine is on firm, level ground.
 - Lift capacities may be limited by local regulations. Please refer to your dealer.

LIFT CAPACITIES – Dipper Length: 2.25m, 4.97m T.A.B., Front stabilisers, Rear stabilisers, No bucket.
JSI60W T.A.B.

Reach	1.5m (4ft 11in)		3m (9ft 10in)		4.5m (14ft 9in)		6m (19ft 8in)		7.5m (24ft 7in)		Capacity at Max Reach				
													kg	kg	mm
Load Point Ht.	kg	kg	kg	kg	kg	kg	kg	kg	kg	kg	kg	kg	kg	mm	
7.5m (24.7ft)													4240*	4240*	4492
6.0m (19.8ft)													3510*	3510*	5935
4.5m (14.9ft)			6720*	6720*	5250*	5250*	4630*	4630*					3270*	3270*	6753
3.0m (9.10ft)					6270*	6270*	4990*	4610					3230*	3230*	7168
1.5m (4.11ft)					7190*	6880	5390*	4450					3350*	3350*	7251
0m			5340*	5340*	7530*	6680	5540*	4340					3670*	3490	7013
- 1.5m (- 4.11ft)			10110*	10110*	7130*	6640	5140*	4330					4330*	3970	6419
- 3.0m (- 9.10ft)					5670*	5670*							5100*	5100*	4882

LIFT CAPACITIES – Dipper Length: 2.70m, 4.97m T.A.B., Front stabilisers, Rear stabilisers, No bucket.
JSI60W T.A.B.

Reach	1.5m (4ft 11in)		3m (9ft 10in)		4.5m (14ft 9in)		6m (19ft 8in)		7.5m (24ft 7in)		Capacity at Max Reach				
													kg	kg	mm
Load Point Ht.	kg	kg	kg	kg	kg	kg	kg	kg	kg	kg	kg	kg	kg	mm	
7.5m (24.7ft)							4410*	4410*					3120*	3120*	5155
6.0m (19.8ft)							4240*	4240*	4170*	4170*			2700*	2700*	6448
4.5m (14.9ft)							4820*	4820*	4330*	4330*			2550*	2550*	7207
3.0m (9.10ft)			8730*	8730*	5870*	5870*	4750*	4660	3200*	3200*			2530*	2530*	7597
1.5m (4.11ft)					6900*	6900*	5220*	4470	3880*	3210			2630*	2630*	7657
0m			6410*	6410*	7430*	6660	5490*	4330					2870*	2870*	7451
- 1.5m (- 4.11ft)			10500*	10500*	7270*	6570	5330*	4290					3340*	3340*	6895
- 3.0m (- 9.10ft)			8830*	8830*	6230*	6230*							4150*	4150*	5913

LIFT CAPACITIES – Dipper Length: 3.05m, 4.97m T.A.B., Front stabilisers, Rear stabilisers, No bucket.
JSI60W T.A.B.

Reach	1.5m (4ft 11in)		3m (9ft 10in)		4.5m (14ft 9in)		6m (19ft 8in)		7.5m (24ft 7in)		Capacity at Max Reach				
													kg	kg	mm
Load Point Ht.	kg	kg	kg	kg	kg	kg	kg	kg	kg	kg	kg	kg	kg	mm	
7.5m (24.7ft)													2580*	2580*	5629
6.0m (19.8ft)							3860*	3860*					2270*	2270*	6831
4.5m (14.9ft)					4440*	4440*	4050*	4050*	2430*	2430*			2150*	2150*	7551
3.0m (9.10ft)			7950*	7950*	5520*	5520*	4520*	4520*	3790*	3260			2140*	2140*	7924
1.5m (4.11ft)			6890*	6890*	6650*	6650*	5040*	4460	4210*	3180			2230*	2230*	7998
0m			6710*	6710*	7320*	6660	5400*	4310	4210*	3126			2420*	2420*	7784
- 1.5m (- 4.11ft)	5120*	5120*	9850*	9850*	7330*	6540	5370*	4240					2800*	2800*	7254
- 3.0m (- 9.10ft)			9410*	9410*	6530*	6530*	4540*	4290					3590*	3590*	6329

Lift capacity front and rear.
 Lift capacity full circle.

- Notes:**
1. For lifting capacity including bucket, subtract total weight of bucket or bucket and quickhitch from above values.
 2. Lifting capacities are based on ISO 10567, that is: 75% of minimum tipping load or 87% of hydraulic lift capacity, whichever is the less. Lifting capacities marked* are based on hydraulic capacity.
 3. Lift capacities assume that the machine is on firm, level ground.
 4. Lift capacities may be limited by local regulations. Please refer to your dealer.

A GLOBAL COMMITMENT TO QUALITY

JCB's total commitment to its products and customers has helped it grow from a one-man business into Britain's largest privately owned manufacturer of backhoe loaders, crawler excavators, wheeled excavators, telescopic handlers, wheeled loaders, dump trucks, rough terrain fork lifts, industrial fork lifts, mini/midi excavators, skid steer loaders, tractors and compaction equipment.

By making constant and massive investments in the latest production technology, the JCB factories have become some of the most advanced in the world.

By leading the field in innovative research and design, extensive testing and stringent quality control, JCB machines have become renowned all over the world for performance, value and reliability.

And with a global sales and service network of more than 650 dealers and agents, we aim to deliver the best customer support in the industry.

Through setting the standards by which others are judged, JCB has become one of the world's most impressive success stories.

