



TANDEM VIBRATORY ROLLERS

CB44B, CB54B, CD44B AND CD54B



CONTENTS

Cat® Features	4, 5
Key Components	6, 7
Operator Comfort	8, 9
Improved Console	10, 11
Drum Choices	12, 13
Quality Compaction	14, 15
Cat® Compaction Control	16
Water Spray	17
Powertrain	18, 19
CB44B Specifications	20, 21
CB54B Specifications	22, 23
CD44B Specifications	24, 25
CD54B Specifications	26, 27



AVAILABLE MODELS ▾



CB44B
Solid Drum



CB44B
Split Drum



CB54B
Solid Drum

SIZED RIGHT

FOR ANY NEED

The expanded line of Cat® Tandem Vibratory Rollers provides you with a broad range of sizes to match just about any job, from parking lots to mainline paving.

While some of the features have changed, the best-in-class vibratory systems haven't. They are easy to match frequency and amplitude to your particular application in order to achieve target densities in the fewest number of passes.

Innovative technology features work quietly behind the scenes. With each roll, temperature can be measured and passes can be counted, more efficiently than ever before.

Operators will notice that they're more comfortable, and that visibility is enhanced, too. Your service technicians, meanwhile, will appreciate extended maintenance intervals. You'll notice improved productivity and machine uptime.

Why settle for any tandem vibratory roller when you can utilize one ideally matched to the size, specifications and requirements of your project?

With Cat Paving Products, you have more models, more comfort, more technology—and ultimately, more profitability.



CB54B
Split Drum



CD44B
Solid Drum



CD44B
Split Drum



CD54B
Solid Drum



CD54B
Split Drum

A FULL RANGE

FOR ANY PAVING APPLICATION.

You can take comfort knowing that no matter how remote the project, service and parts are always available.

HOW CAT® TANDEM VIBRATORY ROLLERS DELIVER

Cat® Tandem Vibratory Rollers feature more drum choices, increased amplitude and improved technology to help you quickly reach quality targets. The industry's longest service intervals reduce the use of consumables and keep the machines running day after day, from dawn to dusk. Don't forget to factor in a high resale value because of the legendary Cat durability.

EXCEPTIONAL VISIBILITY AND CONTROL

- Unobstructed sight lines with standard 180° seat positioning and ability to rotate 360° for excellent all-around visibility
- Innovative handwheel steering technology eliminates front console and delivers precise control
- Finger-tip control for machine functions
- Drum edge and drum surface lighting for easy nighttime operation

SMOOTH OPERATING POWERTRAIN

- Split drum or solid drum capability
- Split-drum design delivers outstanding performance when making turns, eliminates mat tearing and other defects
- Oscillating hitch design delivers best mat finish and improves ride quality on uneven terrain
- Automatic speed control and impact spacing, easily repeat desired working speed
- CB44B, CD44D and CD54D feature Cat C3.4B engines
- CB54B features Cat C4.4 engines
- CD44B and CD54B offer four steering modes: front, leading drum, coordinated front/rear, offset mode mode
- Coordinated steering produces a tight inside turning radius





VERSATILE VIBRATORY SELECTION

- Dual Amplitude/Dual Frequency Vibratory System
 - Automatically optimizes amplitude and frequency with single switch
 - Simple thin/thick lift operation
- Five-Amplitude Vibratory System, heavy hitter for thick lifts and tough mix designs
- Versa Vibe™ Vibratory System, two machines in one for lighter hitting and higher speeds or heavy hitting and slower speeds (CB54B only)
- Total mat coverage: CD44B – 2820 mm (111"); CD54B – 3020 mm (118")

CAT® COMPACTION CONTROL

- Infrared temperature sensors (front and rear) keep operator informed of when optimal temperatures exist for compaction
- Temperature Mapping records temperatures for data analysis
- Pass-Count Mapping keeps operator informed of where mat coverage has taken place and the number of passes made

BEST LIFETIME VALUE

- ECO-mode reduces fuel consumption and lowers sound levels
- Industry-leading vibratory system reliability with extended service intervals
- Oil-bath lubrication for long life of eccentric weight bearings
- Long service intervals for the engine, hydraulics and vibratory system minimize lifetime operating costs

INDUSTRY-LEADING WATER SPRAY SYSTEM

- High capacity system tank provides long duration between fills
- Dual water pumps provide back-up capability and alternate with direction of travel to maximize service life
- Triple filtration prevents clogs with filters located at the fill point, water pumps, and spray nozzles
- Intermittent operation conserves water
- Integrated freeze protection kit (optional) provides protection in cold temperatures when machine is not in use

FEEL THE COMFORT, ENJOY THE PERFORMANCE

1. Versatile vibratory systems
2. Solid or split drum designs
3. Drum surface lighting
4. Engines meet U.S. EPA Tier 4 Interim, EU Stage IIIB emission standards
5. Cool, comfortable operating environment
6. Cat® Compaction Control
7. Machine-to-machine communication
8. Reliable water spray system
9. Drum edge lighting

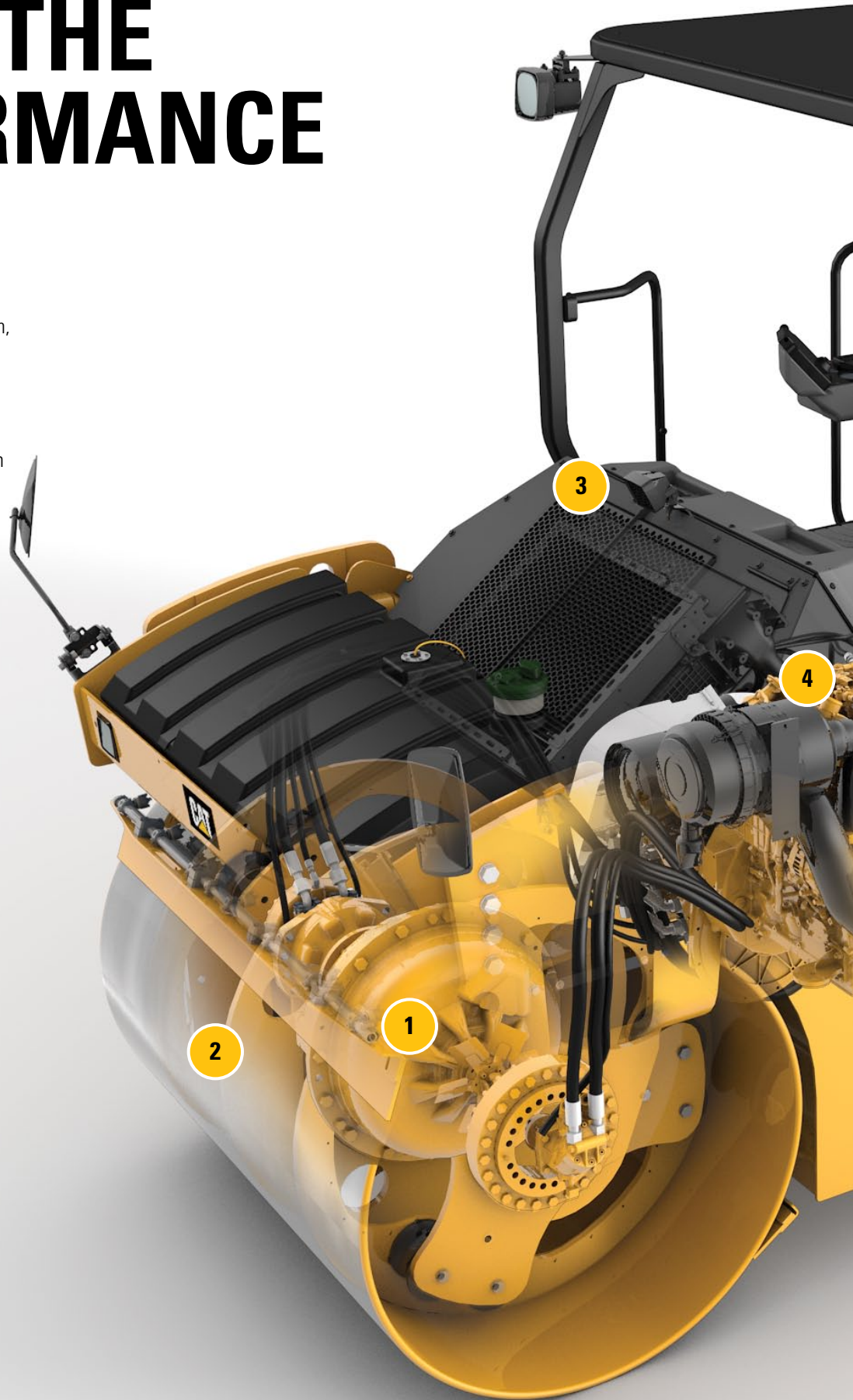



The rollers feature powerful Cat® diesel engines, with ranges between 75 kW (100 hp imperial, 102 metric hp) and 98 kW (131 hp imperial, 133.2 metric hp).



OPERATOR COMFORT

IMPROVED STATION BOOSTS PERFORMANCE.

Caterpillar designs operating stations that provide excellent visibility, control and comfort.

NO SHOCK: COMFORT MATTERS

Cat rollers are built to vibrate. Your operators aren't. That's why comfort is built into every model. The conveniences help keep your operators fresh, which improves productivity and safety. Comfortable equipment also helps you retain key employees, avoiding additional training and hiring costs.

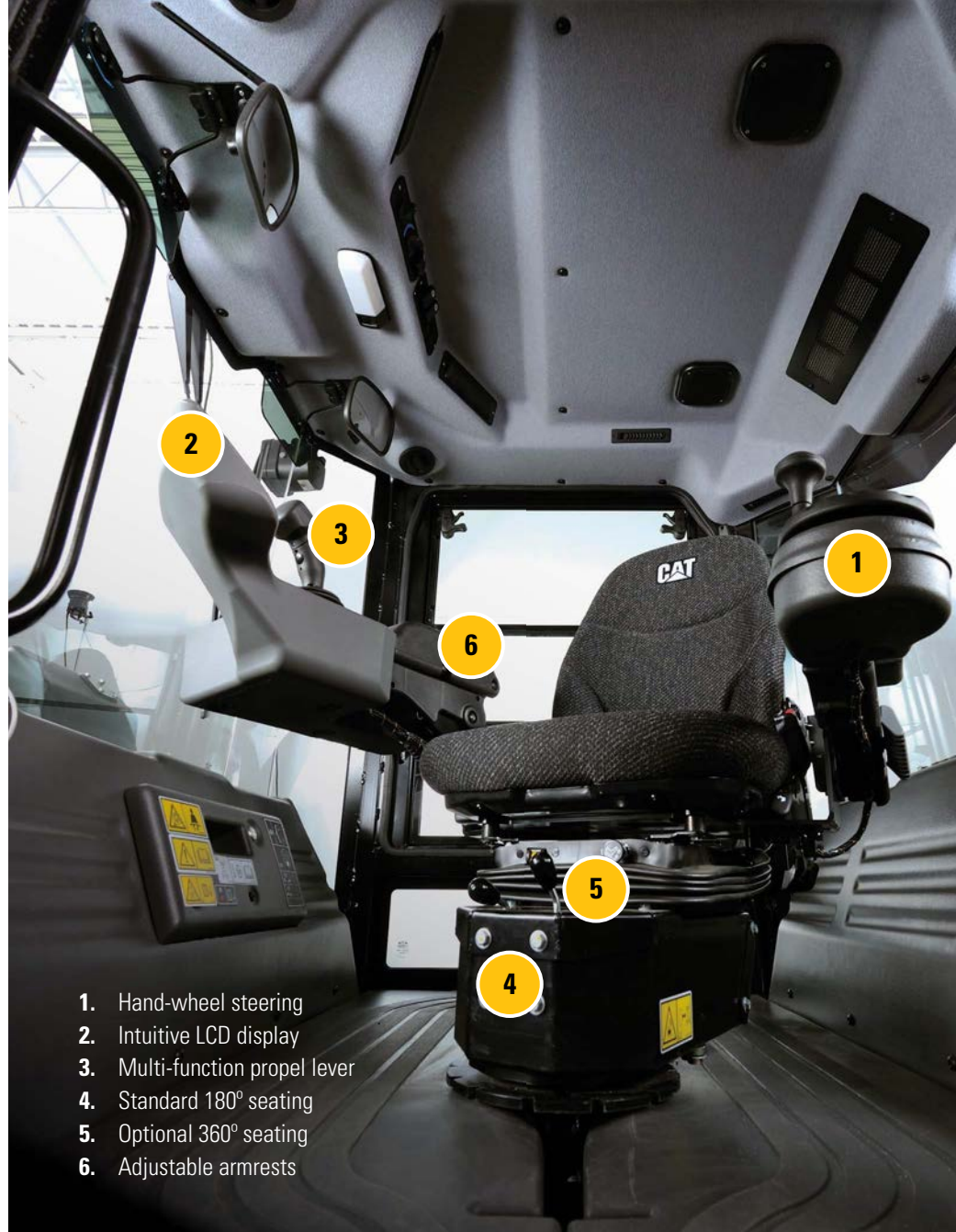

1. Hand-wheel steering
2. Intuitive LCD display
3. Multi-function propel lever
4. Standard 180° seating
5. Optional 360° seating
6. Adjustable armrests

OPERATOR'S STATION

- Controls and LCD Display integrated with pivoting adjustable seat and move with the operator
- Vinyl seat for open-platform configurations; cloth for cab
- Heated option for both cloth and vinyl seats
- Optional deluxe highback air-ride seat
- Vibration-absorbing floor mat
- 12-volt power receptacle supports communication devices
- Comfortable, wide-width seat belt
- Cup holders offer convenience
- Lockable storage compartment

EXCEPTIONAL VISIBILITY AND COMFORT

- Unimpeded views to drum edges
- Unobstructed sight lines with 180° seat positioning and ability to rotate 360°
- Lighting at the drum surface and edge for nighttime operation
- Large mirrors provide wide views to rear
- Standard light package provides excellent lighting; optional additional light package enhances overall illumination
- Low machine noise, low vibration transfer to operator
- Sliding armrest and adjustable seats conform to operator
- Cab features excellent climate control and ventilation with optional air conditioning



FINGERTIP CONTROL

CONSOLE ENABLES OPERATOR TO WORK WITH CONFIDENCE.

UNDER CONTROL

The newly designed console for Cat Tandem Vibratory Rollers is convenient, helping operators quickly find what they need, when they need it. The console's intuitiveness gives operators the confidence they need to leverage the technology, and associated productivity, built into Cat rollers.

MULTI-FUNCTION PROPEL LEVER

- Integrated controls for:
 - Water spray on/off
 - Drum offset
 - Standard on CD44B and CD54B
 - Optional on CB44B and CB54B
 - Vibratory control
 - Optional edge cutter raise/lower control



Cat® control consoles are integrated with pivoting seats, keeping controls and the display right at your fingertips.

LCD DISPLAY

- Multiple functions, including machine data and diagnostics
- Integrated with seat, so it remains in same position even as the seat pivots
- Built-in lockable anti-vandalism cover
- Back-lit for easy visibility in all light conditions
- Multiple language options
- Split-screen capability
- Indicators for:
 - Ground speed
 - Vibrations per minute
 - Fuel level

CONVENIENT CONSOLE

- Integrated with seat providing fingertip access, turns with seat
- Soft keys with tactile feel provide feedback to the operator for intuitive operation
- Emergency Stop button easy to reach and engage



DRUM CHOICES FOR PRODUCTIVITY

SOLID DRUMS = VIBRATORY SYSTEM VERSATILITY

Solid drum models offer more vibratory choices to match your amplitude and frequency requirements, and perform particularly well in high-production applications.

KEY FEATURES

- Perform exceptionally well in vibratory or static mode, enabling a single machine to perform breakdown, intermediate and finishing work
- Offer more vibratory choices to match amplitude and frequency requirements. This drum design performs well in high-production applications
- Are well suited to all types of mix designs and applications
- Provide high amplitudes for breakdown and intermediate work, while their high static linear loads deliver excellent results for finishing work
- Typical applications include highways, city streets, county roads, lane additions, industrial sites, overlays, airport runways, and other high-production paving jobs



Easily fine-tune amplitude settings for the 5-amplitude and Versa Vibe™ systems

SPLIT DRUMS: A TURN FOR THE BETTER

The exclusive split-drum design delivers excellent mat quality in urban environments when frequent turning is required.

KEY FEATURES

The exclusive drum steer propel system provides a tight turning radius without damaging the hot mat.

- When turning, the outside drum half rotates faster than the inside drum, eliminating the potential for shoving and tearing that occurs on standard vibratory drum designs
- The exclusive axle-type pod design utilizes tapered roller bearings that support each drum half and eliminates any potential for contact between the two halves
- Dual seals provide two layers of protection that prevent contamination and ensure long-term performance

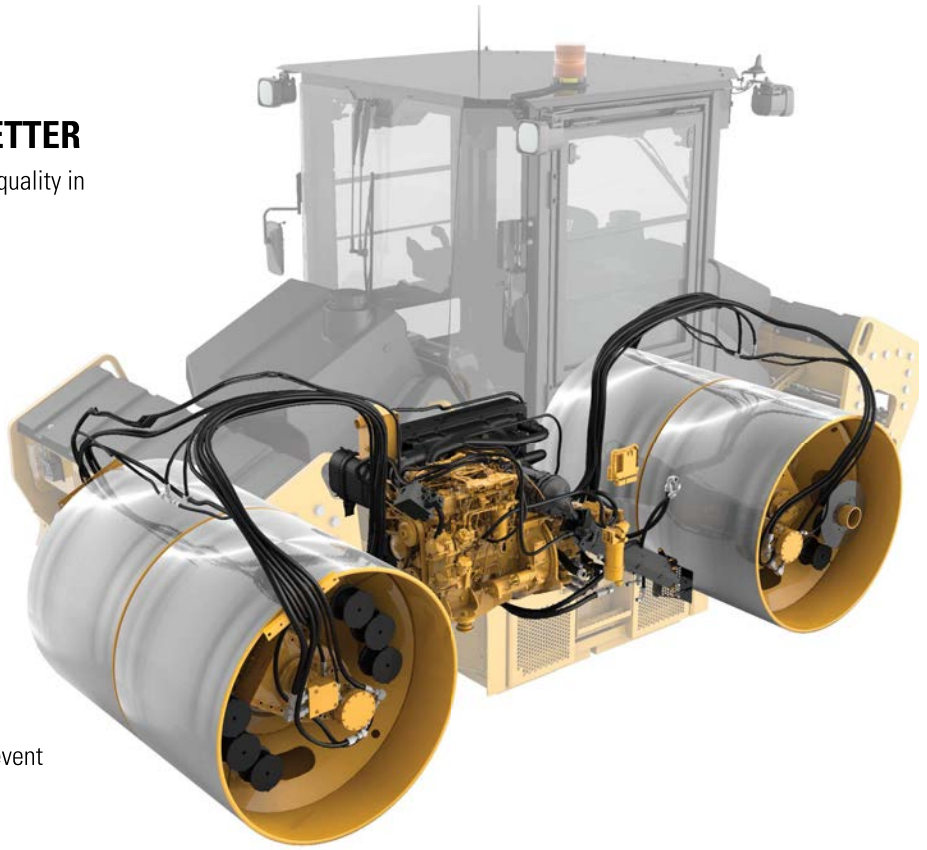

DRUM STEER FEATURES

WIDE DRUM OFFSET

- The 1.3 m (51") drum offset provides more coverage for higher production on thin mats while minimizing heat loss prior to compaction
- Ease of operation is provided through fingertip control at the propel lever, enabling one-handed operation.
- An audio alarm alerts the operator when the drums are aligned, allowing the operator to concentrate on mat conditions

SENSITIVE-TO-THE-TOUCH STEERING

The benefit of electronic steering is combined with the feel of hydraulic steering. When the drum encounters resistance, friction to the steering wheel increases, providing an intuitive feel that is extremely beneficial when operating adjacent to vertical barriers and curbs, or when drum articulation reaches the end of travel during tight turns.

FOUR STEERING MODES

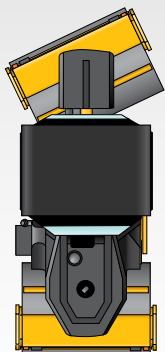

Front Steering

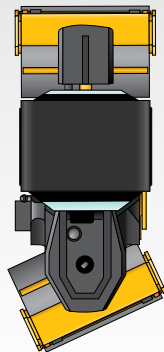

Leading Drum Steering

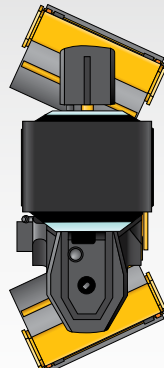

Coordinated Steering

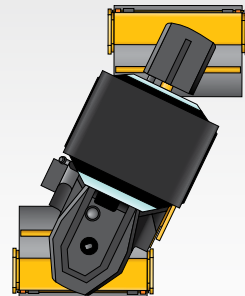

Offset Operation

PACK A PUNCH

ACHIEVE QUALITY COMPACTION FASTER.

DONE RIGHT, DONE NOW

Cat Tandem Vibratory Rollers quickly reach target densities due to their versatile frequency and amplitude selections. These powerful rollers also provide finesse when necessary due to their flexible front or rear drum only vibratory capability.

Easily adjust amplitude and frequency to match the jobsite application.

VIBRATORY SYSTEM

- Options include dual amplitude/dual frequency, Versa Vibe™, and five amplitude settings
- Multiple options that help fine-tune performance on thick, challenging lifts
- Automatic Speed Control feature makes it easier to maintain consistency and impact spacing requirements
- Auto Vibe function helps prevent over-compaction and contributes to uniformity

EXCLUSIVE POD-STYLE VIBRATORY SYSTEM

- Solid drum design exhibits industry-leading vibratory system reliability with 3-year/3000-hour service interval
- Oil-bath lubrication for long life of eccentric weight bearings
- Split-drum design with exclusive tapered roller bearing pod design eliminates contact between drum halves for long-term reliability



DUAL AMPLITUDE / DUAL FREQUENCY VIBRATORY SYSTEM

- Dual amplitude and dual frequency can be tailored to thin/thick lifts
- Single switch control
- Automatically matches amplitude and frequency
- Simple thin/thick lift operation

FIVE AMPLITUDE VIBRATORY SYSTEM

- Heavy hitter for thick lifts and tough mix designs
- Single frequency, five amplitudes
- Easily fine-tune amplitude with drum mounted handwheel

VERSA VIBE™ VIBRATORY SYSTEM

- Two machines in one for lighter hitting and higher speeds or heavy hitting and slower speeds (CB54B only)
- High frequency or high amplitude settings
- Two settings for lighter hitting and higher working speeds on thin lifts
- Two settings for heavier hitting, and slower speeds, on thick lifts
- Four amplitudes, two frequencies
- Simple frequency adjustment
- Breakdown, intermediate, and finish capabilities

CAT® COMPACTION CONTROL

GOING BEYOND OPERATOR INTUITION.

CAT COMPACTION CONTROL

The optional Cat Compaction Control helps contractors increase efficiency and productivity while recording data for quality control documentation and future planning.



TEMPERATURE SENSORS

- Dual infra-red sensors mounted on the front and rear of machine deliver real-time readings
- Keep operator informed of when to begin rolling and when to stop
- Help avoid tender-zones that often occur in the 104°-110° C (219°-230° F) temperature range
- Optimal mat temperatures for compaction
 - Upper limit is around 149° C (300° F)
 - Lower limit is around 85° C (185° F)
- Eliminates hand-held devices

PASS-COUNT MAPPING

- Achieve target density and increase roller efficiency
- Record and monitor pass pattern in order to ensure consistent coverage
- Optimize drum overlap in order to keep pace with the paver
- Simplify nighttime operation
- Eliminate second guessing
- Prevent incomplete passes such as stopping short

TEMPERATURE MAPPING

- Provides a visual readout of mat temperature in order to keep the machine in the proper temperature range
- Records and monitors temperature for future analysis of the proper temperature range

Temperature/Pass Count Mapping

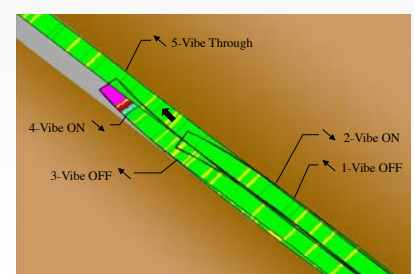
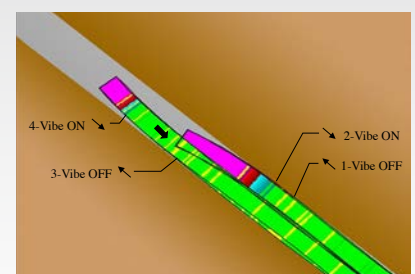
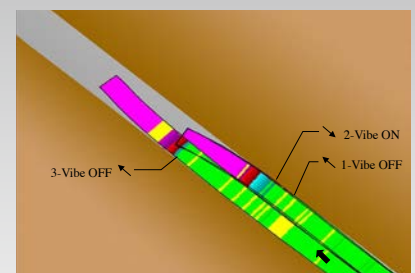
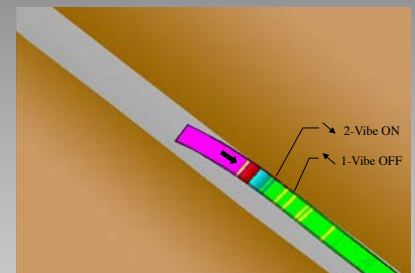
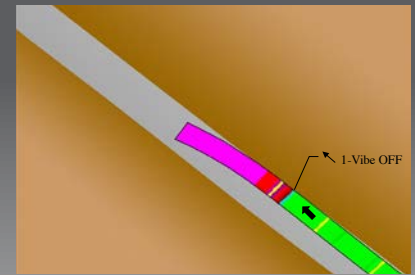

WATER SPRAY SYSTEM

STEADY FLOW, FEWER CLOGS.

KEEP WORK FLOWING

The water tank on Cat tandem vibratory rollers has the capacity to keep your crew moving for hours. The system also is designed to prevent clogging and keep the entire roller drum wet—and the asphalt where it belongs.

CAPACITY, CONVENIENCE

- High capacity system with single fill point provides long duration between refills
- Triple filtration prevents clogs with filters located at the fill point, water pumps, and spray nozzles
- Highly accessible filters can be quickly removed for cleaning without the use of special tools, limiting machine downtime
- Dual water pumps provide the necessary flow to the spray nozzles
- Pump usage alternates with the direction of travel, providing controlled cycling that extends pump life
- Upward spray nozzle orientation allows water to drain back into the supply line, limiting particle accumulation in the nozzle filter
- Constant or adjustable intermittent operation
- Integrated freeze protection kit (optional) provides protection in cold temperatures when machine is not in use

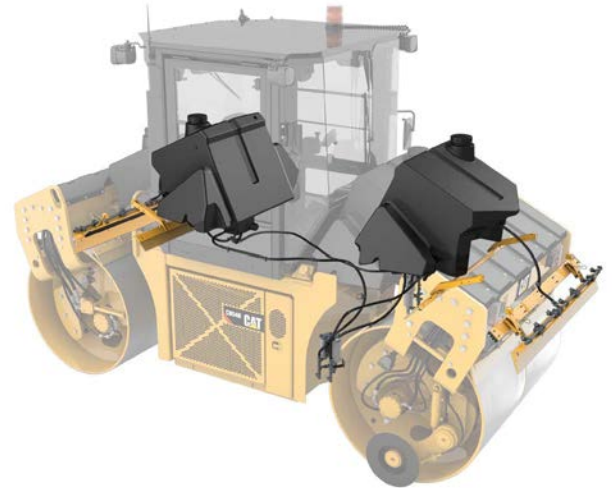

POWERTRAIN

PROVEN POWER, TRACTION, DEPENDABILITY.

STAYING POWER

The B-Series tandem rollers are powered by Cat® engines with ACERT™ Technology. The engine includes a variety of features that help reduce fuel burn, yet still deliver the power required on challenging jobsites. Tough components help extend compactor life.

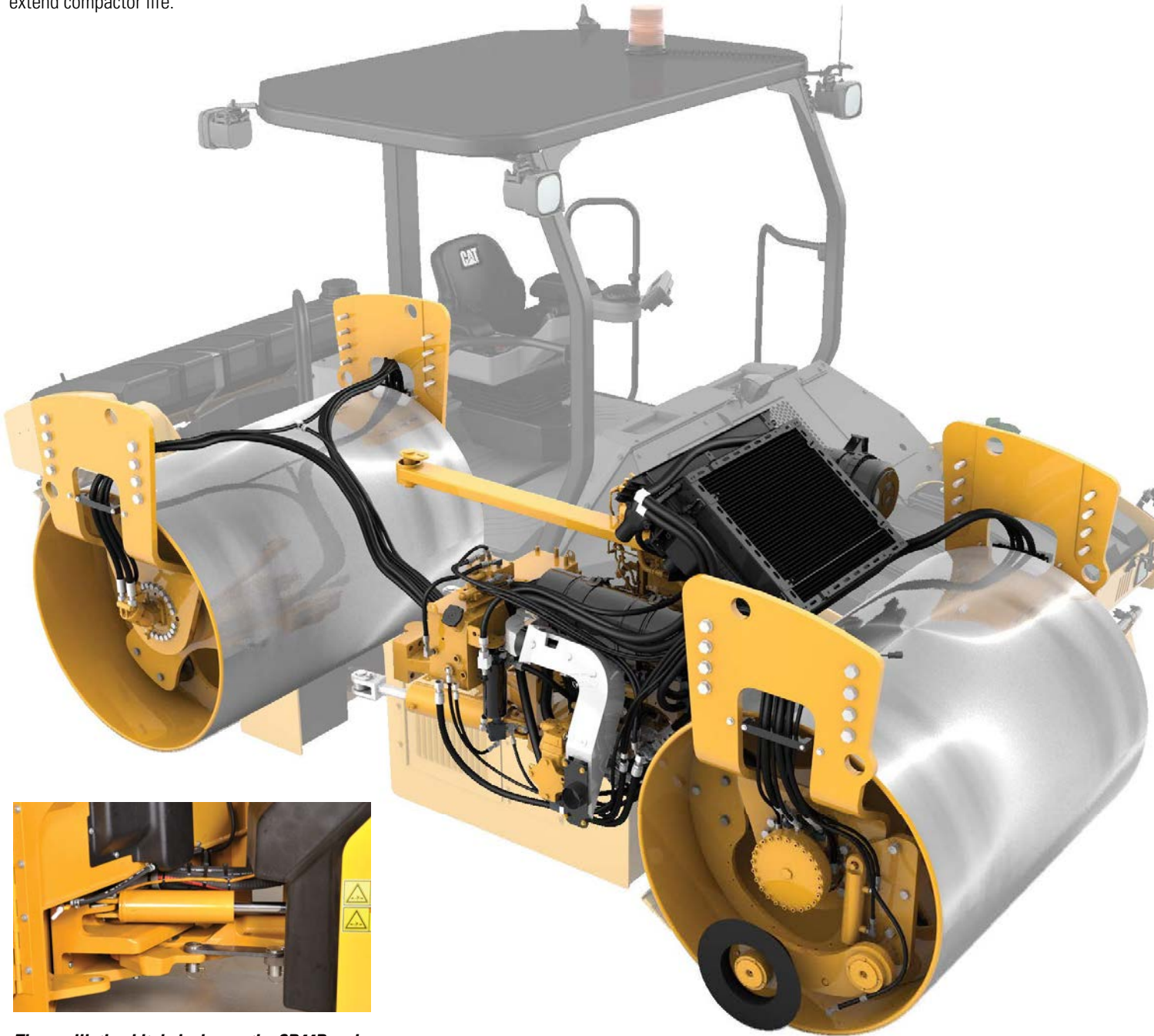

The oscillating hitch design on the CB44B and CB54B improves ride quality on uneven terrain.

POWER, SMOOTH RIDE

- Outstanding performance when rolling resistance is amplified such as inclines and thick lifts
- Centered articulation hitch allows the drums to track in the same path while turning

ENGINE

- Features electronic control module (ECM), providing optimal performance through precisely synchronized timing and fuel delivery
- ECM enables advanced troubleshooting and diagnostic capabilities using Electronic Technician (Cat ET)
- Cat Dealers are the single-source providers of all machine and engine warranty service (a Cat exclusive)
- Easy access to entire engine compartment and cooling module for easy, fast servicing
- Sustainable features include meeting EPA Tier 4 Interim and EU Stage IIIB emission standards, and a thick block/robust components for extended life and lower noise levels

CAT ENGINES OPTIMIZED FOR POWER, EFFICIENCY

CB44B, CD44B/54B

75 kW (100 hp)

CB54B

98 kW (131 hp)

*Gross power: ISO 14396
Rated Speed: 2,200 rpm*

HIGH CAPACITY COOLING SYSTEM

- The large capacity cooling system keeps the operating temperatures low, even in extreme conditions
- The high capacity fans direct warm air away from the operator for a more comfortable operating environment

AIR FLOW PATTERN



CB44B

ARTICULATING ROLLER.



APPLICATIONS

- Highways, urban streets, parking lots, rural roads
- Covers widths up to 3.65 m (12') in three overlapping passes
- Recommended for lift thicknesses up to 76 mm (3")

AVAILABLE IN SOLID OR
SPLIT DRUM MODELS >



Solid Drum



Split Drum

Weights

Operating Weight - Split Drum w/ROPS/FOPS/CAB

Standard machine - kg (lb)	9 330 (20,569)
Maximum machine - kg (lb)	10 470 (23,082)
Static linear load - kg/cm (lb/in)	31.1 (174)

Operating Weight - Solid Drum w/ROPS/FOPS/CAB

Standard machine - kg (lb)	8 190 (18,056)
Maximum machine - kg (lb)	8 940 (19,709)
Static linear load - kg/cm (lb/in)	26.9 (151)

Operating Weight - Split Drum w/ROPS/FOPS/CANOPY

Standard machine - kg (lb)	9 030 (19,908)
Maximum machine - kg (lb)	10 250 (22,597)
Static linear load - kg/cm (lb/in)	29.8 (167)

Operating Weight - Solid Drum w/ROPS/FOPS/CANOPY

Standard machine - kg (lb)	7 990 (17,615)
Maximum machine - kg (lb)	8 720 (19,224)
Static linear load - kg/cm (lb/in)	26.3 (147)

Service Refill Capacities

Fuel Tank - L (gal)	208 (55)
Fuel Usage (50% duty) - hours	12
Water Tank - L (gal)	742 (196)

Engine - Powertrain

Engine Model	Cat® C3.4B with ACERT™ Technology
Number of Cylinders	4
Rated Speed - rpm	2200

Gross Power:

Tier 4 Interim, Stage IIIB - kW (hp)	75 kW (100 (l), 102 (m))
--------------------------------------	--------------------------

Speed Ranges:

Low - km/hr (mph)	0 - 7 (0 - 4.3)
High - km/hr (mph)	0 - 12 (0 - 7.5)

Vibratory Systems

Dual Amplitude, Dual Frequency - Split Drum

Frequency – Hz (vpm)	45/53.3 (2,520/3,200)
Amplitude – mm (in)	0.62 - 0.31 (0.024 - 0.012)

Dual Amplitude, Dual Frequency - Solid Drum

Frequency – Hz (vpm)	53.3/63.3 (3,200/3,800)
Amplitude – mm (in)	0.65 - 0.31 (0.026 - 0.012)

Dual Amplitude, Dual Frequency - Solid Drum

Frequency – Hz (vpm)	45/53.3 (2,700/3,200)
Amplitude – mm (in)	0.65 - 0.31 (0.026 - 0.012)

Five Amplitude - Solid Drum

Frequency – Hz (vpm)	53.3 (3,200)
Amplitude – mm (in) high	0.64 (0.025)
Amplitude – mm (in) medium high	0.56 (0.022)
Amplitude – mm (in) medium	0.45 (0.018)
Amplitude – mm (in) medium low	0.35 (0.014)
Amplitude – mm (in) low	0.25 (0.010)

STANDARD AND OPTIONAL EQUIPMENT

Standard Equipment:

- 2-Amplitude/2-Frequency Vibe System
- 12-Volt Electrical System
- 120 Amp Alternator
- 742 L (196 gal) Water Tank Capacity
- Automatic Speed Control
- Automatic Vibratory Control
- ECO-mode
- Front and Rear Solid Drums
- Locking Engine Compartment
- ROPS/FOPS Platform
- Rotating and Sliding Station
- Triple Filtered Water Spray System
- Two-Speed Hydrostatic Transmission
- Sealed Pod Vibratory System
- Suspension Seat
- Working Lights

Optional Equipment:

- 5-Amplitude Vibratory System
- Air Conditioning
- Air Suspension Seat w/Heat
- Bio-Degradable Oil
- Chip Spreader Ready (split drum)
- Cat® Compaction Control
- Edge Cutter
- Freeze Protection Kit
- Front and Rear Split Drums
- High Ambient Cooling System
- Halogen Lights w/Drum Edge Lights
- High Intensity Discharge (HID) Lights w/ Drum Edge Lighting
- Mirrors
- Product Link
- Recording Module (cab only)
- Rooding Lights
- ROPS/FOPS Cab
- Temperature Indicator (asphalt)
- Warning Beacon
- Water Distribution Mats (cocoa)
- Water Distribution Mats (rubber)

CB54B

ARTICULATING ROLLER.



APPLICATIONS

- Interstates, highways, urban streets, large parking lots, rural roads
- Covers widths up to 4.8 m (16') in three overlapping passes
- Recommended for lift thicknesses up to and greater than 101 mm (4")

AVAILABLE IN SOLID OR
SPLIT DRUM MODELS >



Solid Drum



Split Drum

Weights

Operating Weight - Split Drum w/ROPS/FOPS/CAB

Standard machine - kg (lb)	10 670 (23,525)
Maximum machine - kg (lb)	12 160 (26,808)
Static linear load - kg/cm (lb/in)	31.5 (176)

Operating Weight - Solid Drum w/ROPS/FOPS/CAB

Standard machine - kg (lb)	9 710 (21,407)
Maximum machine - kg (lb)	10 510 (23,171)
Static linear load - kg/cm (lb/in)	28.5 (160)

Operating Weight - Split Drum w/ROPS/FOPS/CANOPY

Standard machine - kg (lb)	10 410 (22,950)
Maximum machine - kg (lb)	11 790 (25,995)
Static linear load - kg/cm (lb/in)	30.8 (173)

Operating Weight - Solid Drum w/ROPS/FOPS/CANOPY

Standard machine - kg (lb)	9 500 (20,945)
Maximum machine - kg (lb)	10 235 (22,564)
Static linear load - kg/cm (lb/in)	27.8 (156)

Service Refill Capacities

Fuel Tank - L (gal)	208 (55)
Fuel Usage (50% duty) - hours	12
Water Tank - L (gal)	837 (221)

Engine - Powertrain

Engine Model	Cat® C4.4 with ACERT™ Technology
Number of Cylinders	4
Rated Speed - rpm	2,200

Gross Power:

Tier 4 Interim, Stage IIIB - kW (hp)	98 kW (131 (l), 133.2 (m))
--------------------------------------	----------------------------

Speed Ranges:

Low - km/hr (mph)	0 - 7 (0 - 4.3)
High - km/hr (mph)	0 - 11 (0 - 7)

Vibratory Systems

Dual Amplitude, Dual Frequency - Split Drum

Frequency – Hz (vpm)	42/53.3 (2,520/3,200)
Amplitude – mm (in)	0.61 - 0.33 (0.024 - 0.013)

Dual Amplitude, Dual Frequency - Solid Drum

Frequency – Hz (vpm)	45/63.3 (2,580/3,800)
Amplitude – mm (in)	0.82 - 0.32 (0.032 - 0.012)

Dual Amplitude, Dual Frequency - Solid Drum

Frequency – Hz (vpm)	45/63.3 (2,580/3,800)
Amplitude – mm (in)	0.82 - 0.32 (0.032 - 0.014)

Versa-Vibe™ - Solid Drum

Frequency – Hz (vpm)	43 (2580)
Amplitude – mm (in) high	0.86 (0.034)
Amplitude – mm (in) low	0.72 (0.028)
Frequency – Hz (vpm)	63.3 (3800)
Amplitude – mm (in) high	0.39 (0.015)
Amplitude – mm (in) low	0.26 (0.010)

Five amplitude - Solid Drum

Frequency – Hz (vpm)	43 (2580)
Amplitude – mm (in) high	1.06 (0.042)
Amplitude – mm (in) medium high	0.91 (0.036)
Amplitude – mm (in) medium	0.73 (0.029)
Amplitude – mm (in) medium low	0.54 (0.021)
Amplitude – mm (in) low	0.34 (0.013)

STANDARD AND OPTIONAL EQUIPMENT

Standard Equipment:

- 2-Amplitude/2-Frequency Vibe System
- 12-Volt Electrical System
- 120 Amp Alternator
- 837 L (221 gal) Water Tank Capacity
- Automatic Speed Control
- Automatic Vibratory Control
- ECO-mode
- Front and Rear Solid Drums
- Locking Engine Compartment
- ROPS/FOPS Platform
- Triple Filtered Water Spray System
- Two-Speed Hydrostatic Transmission
- Sealed Pod Vibratory System
- Solid Drums
- Suspension Seat
- Working Lights

Optional Equipment:

- 5-Amplitude Vibratory System
- Air Conditioning (cab only)
- Air Suspension Seat w/Heat
- Bio-Degradeable Oil
- Cat Compaction Control
- Chip Spreader Ready (split drum)
- Edge Cutter
- Freeze Protection Kit
- Front and Rear Split Drums
- High Ambient Cooling System
- Halogen Lights w/Drum Edge Lights
- High Intensity Discharge (HID) Lights w/Drum Edge Lighting
- Mirrors
- Product Link
- Recording Module (cab only)
- Roading Lights
- ROPS/FOPS Cab
- Split Drums
- Temperature Indicator (asphalt)
- Versa Vibe™ Vibratory System
- Warning Beacon
- Water Distribution Mats (cocoa)
- Water Distribution Mats (rubber)

CD44B

DRUM-STEER ROLLER.



APPLICATIONS

- Cul-de-sacs, confined areas, highways, urban streets, parking lots, rural roads
- Covers widths up to 3.6 m (12') in three overlapping passes
- Offset mode covers widths up to 2.8 m (9' 3")
- Recommended for lift thicknesses up to 76 mm (3")

**AVAILABLE IN SOLID OR
SPLIT DRUM MODELS** >



Solid Drum



Split Drum

Weights

Operating Weight - Split Drum w/ROPS/FOPS/CAB

Standard machine - kg (lb)	8 390 (18,497)
Maximum machine - kg (lb)	9 450 (20,834)
Static linear load - kg/cm (lb/in)	27.9 (170)

Operating Weight - Solid Drum w/ROPS/FOPS/CAB

Standard machine - kg (lb)	7 400 (16,314)
Maximum machine - kg (lb)	7 980 (17,593)
Static linear load - kg/cm (lb/in)	24.5 (150)

Operating Weight - Split Drum w/ROPS/FOPS/CANOPY

Standard machine - kg (lb)	8 190 (18,056)
Maximum machine - kg (lb)	9 220 (20,327)
Static linear load - kg/cm (lb/in)	27.2 (166)

Operating Weight - Solid Drum w/ROPS/FOPS/CANOPY

Standard machine - kg (lb)	7 200 (15,873)
Maximum machine - kg (lb)	7 760 (17,108)
Static linear load - kg/cm (lb/in)	23.9 (146)

Service Refill Capacities

Fuel Tank - L (gal)	135 (36)
Fuel Usage (50% duty) - hours	12
Water Tank - L (gal)	600 (159)

Engine - Powertrain

Engine Model	Cat® C3.4B with ACERT™ Technology
Number of Cylinders	4
Rated Speed - rpm	2,200

Gross Power:

Tier 4 Interim, Stage IIIB - kW (hp)	75 kW (100.5 (l), 101.9 (m))
--------------------------------------	------------------------------

Speed Ranges:

Low - km/hr (mph)	0 - 7 (0 - 4.3)
High - km/hr (mph)	0 - 12 (0 - 7.5)

Vibratory Systems

Dual Amplitude, Dual Frequency - Split Drum

Frequency – Hz (vpm)	42/55.3 (2,520/3,200)
Amplitude – mm (in)	0.62 - 0.31 (0.024 - 0.012)

Dual Amplitude, Dual Frequency - Solid Drum

Frequency – Hz (vpm)	45/53.3 (2520/3200)
Amplitude – mm (in)	0.68 - 0.34 (0.027 - 0.013)

Dual Amplitude, Dual Frequency - Solid Drum

Frequency – Hz (vpm)	53.3/66.7 (3,200/4,000)
Amplitude – mm (in)	0.65 - 0.31 (0.026 - 0.012)

Dual Amplitude, Dual Frequency - Solid Drum

Frequency – Hz (vpm)	45/53.3 (2,700/3,200)
Amplitude – mm (in)	0.67 - 0.35 (0.026 - 0.014)

STANDARD AND OPTIONAL EQUIPMENT

Standard Equipment:

- 2-Amplitude/2-Frequency Vibe System
- 12-Volt Electrical System
- 120 Amp Alternator
- 600 L (158 gal) Water Tank Capacity
- Automatic Traction Control
- Front and Rear Solid Drums
- Locking Engine Compartment
- Roading Lights
- ROPS/FOPS Platform
- Sealed Pod Vibratory System
- Suspension Seat
- Triple-Filtered Water Spray System
- Two-Speed Hydrostatic Transmission

Optional Equipment:

- Air Conditioning (cab only)
- Air Suspension Seat w/Heat
- Bio-Degradable Oil
- Cat Compaction Control
- Chip Spreader Ready (split drum)
- Edge Cutter
- Freeze Protection Kit
- Front and Rear Split Drums
- Halogen Lights w/Drum Edge Lights
- High Ambient Cooling System
- High Intensity Discharge (HID) w/Drum Edge Lighting
- Mirrors
- Product Link
- Recording Module (cab only)
- Roading Lights
- ROPS/FOPS Cab
- Temperature Indicator (asphalt)
- Warning Beacon
- Water Distribution Mats (cocoa)
- Water Distribution Mats (rubber)

CD54B

DRUM-STEER ROLLER.



APPLICATIONS

- Cul-de-sacs, confined areas, interstates, highways, urban streets, large parking lots, rural roads
- Covers widths up to 4.8 m (16') in three overlapping passes
- Offset mode covers widths up to 3 m (9' 10")
- Recommended for lift thicknesses up to and greater than 101 mm (4")

**AVAILABLE IN SOLID OR
SPLIT DRUM MODELS** >



Solid Drum



Split Drum

Weights

Operating Weight - Split Drum w/ROPS/FOPS/CAB

Standard machine - kg (lb)	10 120 (22,311)
Maximum machine - kg (lb)	11 440 (25,220)
Static linear load - kg/cm (lb/in)	29.5 (165)

Operating Weight - Solid Drum w/ROPS/FOPS/CAB

Standard machine - kg (lb)	9 030 (19,908)
Maximum machine - kg (lb)	9 740 (21,475)
Static linear load - kg/cm (lb/in)	26.5 (148)

Operating Weight - Split Drum w/ROPS/FOPS/CANOPY

Standard machine - kg (lb)	9 860 (21,738)
Maximum machine - kg (lb)	11 170 (24,625)
Static linear load - kg/cm (lb/in)	28.6 (160)

Operating Weight - Solid Drum w/ROPS/FOPS/CANOPY

Standard machine - kg (lb)	8 770 (19,335)
Maximum machine - kg (lb)	9 470 (20,880)
Static linear load - kg/cm (lb/in)	25.8 (145)

Service Refill Capacities

Fuel Tank - L (gal)	135 (36)
Fuel Usage (50% duty) - hours	12
Water Tank - L (gal)	750 (198)

Engine - Powertrain

Engine Model	Cat® C3.4B with ACERT™ Technology
Number of Cylinders	4
Rated Speed - rpm	2,200

Gross Power:

Tier 4 Interim, Stage IIIB - kW (hp)	75 kW (100.5 (l), 101.9 (m))
--------------------------------------	------------------------------

Speed Ranges:

Low - km/hr (mph)	0 - 7 (0 - 4.3)
High - km/hr (mph)	0 - 11 (0 - 7)

Vibratory Systems

Dual Amplitude, Dual Frequency - Split Drum

Frequency – Hz (vpm)	42/53.3 (2,520/3,200)
Amplitude – mm (in)	0.61 - 0.33 (0.023 - 0.013)

Dual Amplitude, Dual Frequency - Solid Drum

Frequency – Hz (vpm)	45/53.3 (2,700/3,200)
Amplitude – mm (in)	0.82 - 0.32 (0.026 - 0.013)

STANDARD AND OPTIONAL EQUIPMENT

Standard Equipment:

- 2-Amplitude/2-Frequency Vibe System
- 12-Volt Electrical System
- 120 Amp Alternator
- 750 L (198 gal) Water Tank Capacity
- Automatic Speed Control
- Automatic Traction Control
- Automatic Vibratory Control
- ECO-mode
- Front and Rear Solid Drums
- Locking Engine Compartment
- Rooding Lights
- ROPS/FOPS Platform
- Suspension Seat
- Triple-Filtered Water Spray System
- Two-Speed Hydrostatic Transmission

Optional Equipment:

- Air Conditioning
- Air Suspension Seat w/Heat
- Bio-Degradable Oil
- Cat Compaction Control
- Chip Spreader Ready (split drum)
- Edge Cutter
- Freeze Protection Kit
- Front and Rear Solid Drums
- Halogen Lights w/Drum Edge Lights
- High Ambient Cooling System
- High Intensity Discharge (HID) w/Drum Edge Lighting
- IRH Compliant
- Mirrors
- Product Link
- Recording Module (cab only)
- Rooding Lights
- ROPS/FOPS Cab
- Split Drums
- Temperature Indicator (asphalt)
- Warning Beacon
- Water Distribution Mats (cocoa)
- Water Distribution Mats (rubber)

Having a goal like being the paving industry sales leader is no small challenge, even for the worldwide leader in the manufacture of equipment for the construction industry.

But ever since we sold our first paving equipment in 1986, we have continued to grow. Over the years, our machines have been recognized as dependable and rugged, easy to use and highly productive.

We have introduced innovations that have changed the way the world builds roads, features that our competitors now offer on their machines.

And with each new generation of machines we introduce, more and more customers around the world make the decision to switch to Cat.

For more complete information on Cat products, dealer services, and industry solutions, visit us on the web at www.cat.com.

**PAVING ALL DAY.
EVERY DAY.**



QEDQ1610 (06/12)

© 2012 Caterpillar
All Rights Reserved

Materials and specifications are subject to change without notice.

Featured machines in photography may include additional equipment for special applications.

CAT, CATERPILLAR, their respective logos, "Caterpillar Yellow" and the POWER EDGE trade dress, as well as corporate and product identity used herein, are trademarks of Caterpillar and may not be used without permission.

